

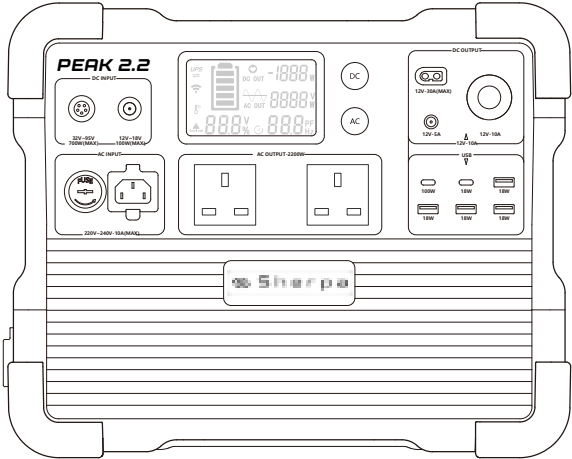

PEAK 2.2







Please read the user manual thoroughly before using



CONTENTS

Box Contents	01
Charging Times	01
Specifications	02
Function Overview	03
How to use the PEAK 2.2	04-10
Display Overview	04
UPS Mode	05
Adjusting Settings	05-06
Adding Extra Capacity	07
Charging the PEAK 2.2	07-12
Solar Charge Configurations	08-10
FAQs	11
Disclaimer	12
Safety Advice	12-13
Disposal	13
Warranty Exclusions	14
Support	14

BOX CONTENTS

				
PEAK 2.2 *1 and Spare corner protectors *4	AC Charging Cable *1	MC4 Solar Charging Cable(LSMC4-5GX16) *1	Car Charging Cable *1	12V Alligator Clips *1

CHARGING TIMES

 Wall Charger	 Electric Generator	 Car Charger
Around 1.8Hours	Around 1.8Hours	Approx 18 h (via aux port) Or 3-4 h (via Sherpa Charge-500)

⚠ When charging from a generator, please use a voltage regulator to prevent damage to the power unit (or fuse blow).

SOLAR CHARGE TIME

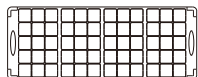

solar panel









MC4 Solar Charging Cable







200W	400W	600W
9~10 Hours	5~6 Hours	3.5~4 Hours

The solar charging time depends on weather conditions and panel tilt. PEAK 2.2 has a built-in MPPT charge controller that supports 32-95V, 15A PV charging up to 700W.



SPECIFICATIONS

						
Capacity	Battery Type	Charging Time	Protections	Temperature	Dimension	Net Weight
1536Wh (120Ah)	LiFePO4 Battery Retains 80%+ Original Capacity At 3500 Cycles	0.9H to 80% 1.8H to 100%	Over-Voltage, Overheat, Overload, Short-Circuit, Self-Recovery	0°C~45°C/32°F~113°F (Charging) -20°C~45°C/-4°F~113°F (Discharging)	L377*W237*H305 mm	18kg

OUTPUT SPECS

						
AC Out *2	USB-A *4	USB-C *2	XT60 Output *1	Aux Car Port *1	DC 5525 Output *1	Wireless Charger *1
Pure sine wave 220V-240V Rated 2200W	(5V,9V,12V, Max 18W)*4	(5V,9V,12V, Max 18W)*1 (5V,9V,12V,20V, Max 100W)*1	DC 12V-30A	DC 12V-10A	DC 12V-5A	Max 15W

INPUT SPECS

		
GX16MF *1	5521 *1	AC INLET *1
DC Charging (32V-95V) Max 700W Max 15A	DC Charging (12V-18V) Max 100W Max 7A	AC 220V-240V 1400W

UPS SPECS

AC 220V-240V Max 10A

EXPANSION

Port For Cascade *1
Cascadable with Peak 3.0-EB

FUNCTION OVERVIEW

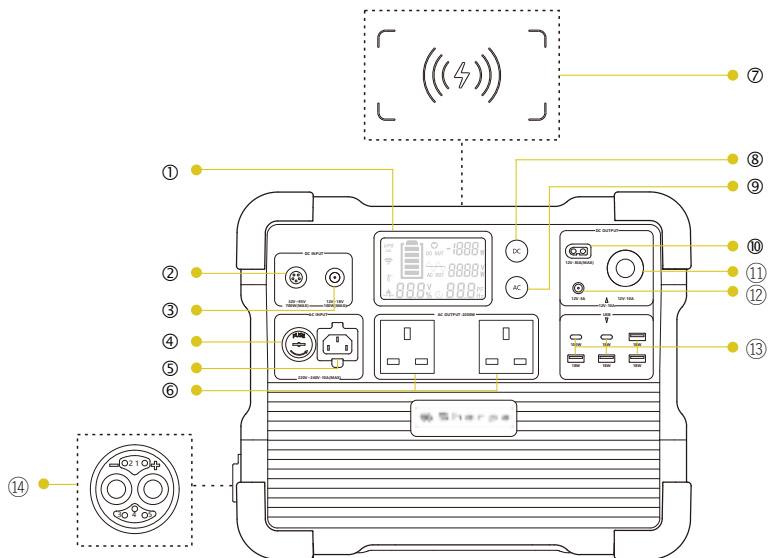

① LCD Display

② DC 32V-95V Charging Port

③ DC 12V-18V Charging Port

④ Fuse

⑤ AC 220V-240V Input

⑥ AC 220V-240V Output

⑦ Wireless Charger

⑧ DC 12V/USB/Wireless ON/OFF

⑨ AC 220V-240V ON/OFF

⑩ DC12V XT60 Output

⑪ DC12V Auxiliary Output

⑫ DC12V (5525) Output

⑬ USB-A/USB-C Ports

⑭ Battery Expansion Port

HOW TO USE THE PEAK 2.2

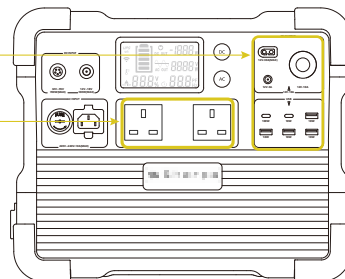
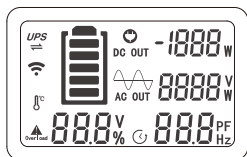

press and hold to turn on / off DC / USB / Wireless Charger

press and hold to turn on / off AC

Note: Turn AC OFF when not in use to save the battery energy.

DISPLAY OVERVIEW

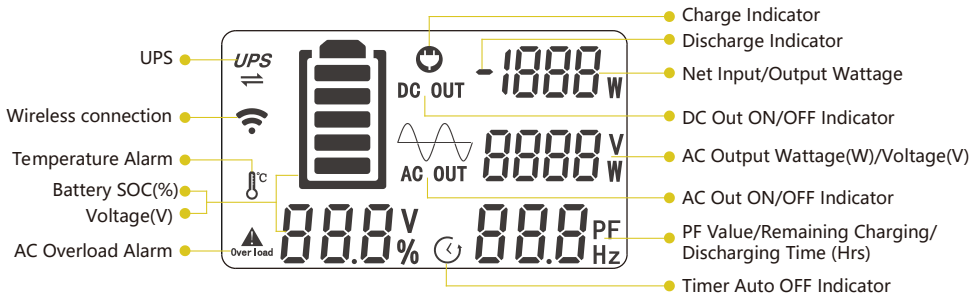

Temperature Alarm Icon

The operating temperature range of PEAK 2.2 is -20~45°C. If it outputs high power in a hot conditions for a long time, the high temperature alarm icon will flash, indicating that the inverter is overheating, and the AC output will be disabled automatically.



AC Overload Alarm Icon

PEAK 2.2 can power most devices with power consumption less than 2200 watts.

If your devices exceed 2200W, even for a brief spike, the AC overload alarm indicator flashes and AC mode shuts off.



UPS function prompt

When the unit has AC input connected and the AC output is turned on, the UPS icon will show to indicate it is active.



Wireless function prompt

When the power station is connected to the network via WIFI, this icon remains visible.

UPS MODE

The PEAK 2.2 supports UPS function. It can provide the loads (such as computers, data centres, telecommunication equipment) Near-instantaneous (8-20ms) protection from unexpected power interruptions from the main power supply.

Note: Not suitable to specific applications that need transfer time under 8ms, such as servers and workstations.

The UPS function only supports protection for loads under 2200W, please check that your devices will not exceed this to avoid overload and auto-shut-off.

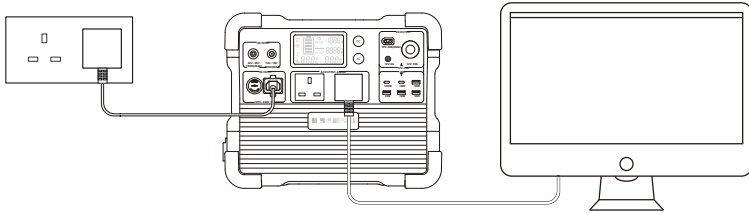

ADJUSTING PEAK 2.2 SETTINGS

- 1 : After powering on, long-press the AC and DC switch at the same time. The battery symbol will flash
- 2 : Now long-press DC to enter settings.

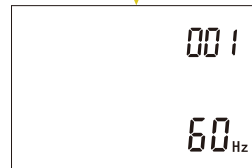
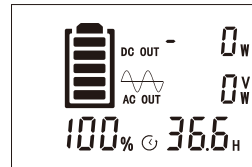

Setting 001 - AC output frequency (advanced users): press DC to select 50Hz or 60Hz. Then short press AC to go to the next option.

Setting 002 - AC output voltage:
Short press DC to adjust voltage to 220 or 230V.
Short press AC to go to the next option.

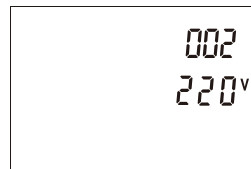

Setting 003 – No-load auto shut off timer (default OFF).
The unit detects when there is no AC load and starts the timer for auto OFF to save energy.
Short press DC to cycle the time delay in hours.
Short press AC to go to the next option.

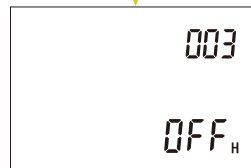

Setting 004 - WIFI reset function (default OFF).
Short press DC, the screen will show 'rst' which means the reset command is activated and the WIFI connection details will be wiped.

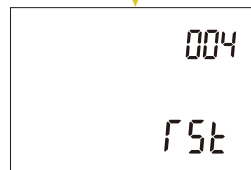

3 : Short press AC to confirm all settings. The display will show EEP to confirm successful configuration.

ADDING EXTRA CAPACITY

The MJ32 socket can be used to cascade two PEAK 3.0-Extra Batteries to achieve a total of 7,680Wh storage capacity. Use the connector cables provided with the PEAK 3.0-EB and follow the instructions provided with them.

After cascading the extra battery successfully, the display will show the total percentage of the host and the extra battery capacities.

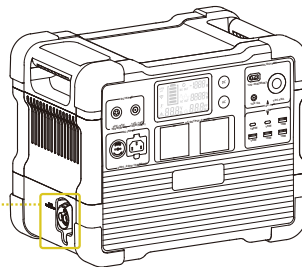
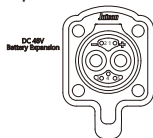

CHARGING THE PEAK 2.2

1. GX16MF-5 Charging Port: PV/DC (operating voltage) range 32V-95V, 700W maximum; Voc (open circuit voltage) of solar panel/array must be less than 95V or it will damage the unit. **Do not wire more than two 36V solar panels in series, or more than four 18V solar panels in series.** (18V/36V stands for Vmp, the operating voltage, of the solar panel)

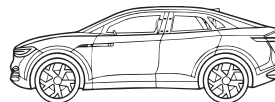
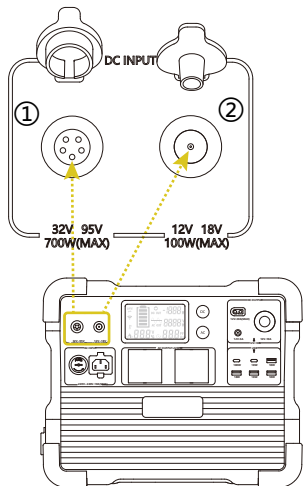

2. DC5521 Charging Port:

PV/DC 12V-18V, 100W maximum; suitable for the car charger.

Voc (open circuit voltage) of a solar panel must be less than 18V.

SOLAR CHARGE CONFIGURATIONS

Charging the PEAK 2.2 with a single panel

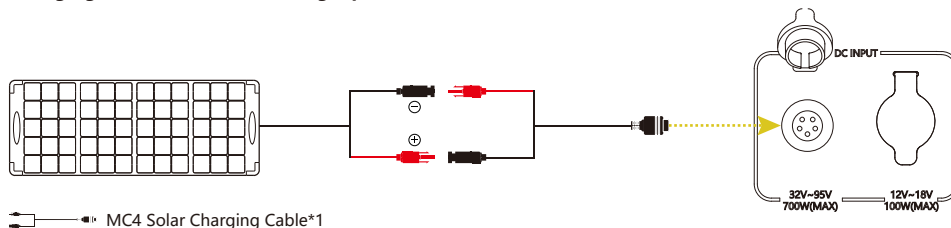

MC4 Solar Charging Cable*1

The Voc of a single solar panel should not exceed 95V, and the Vmp should be greater than 32V.

Use two solar panels in series to charge the PEAK 2.2

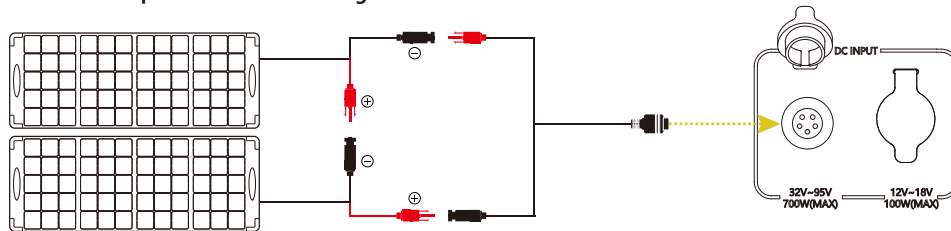

MC4 Solar Charging Cable*1

The Voc of each solar panel should not exceed 48V, and the Vmp of each should be greater than 16V. Series wiring effectively combines voltages, not the amperage.

SOLAR CHARGE CONFIGURATIONS

Using multiple solar panels in parallel to charge the PEAK 2.2

(It is recommended to use solar panels of the same specification and model to obtain the best results.)

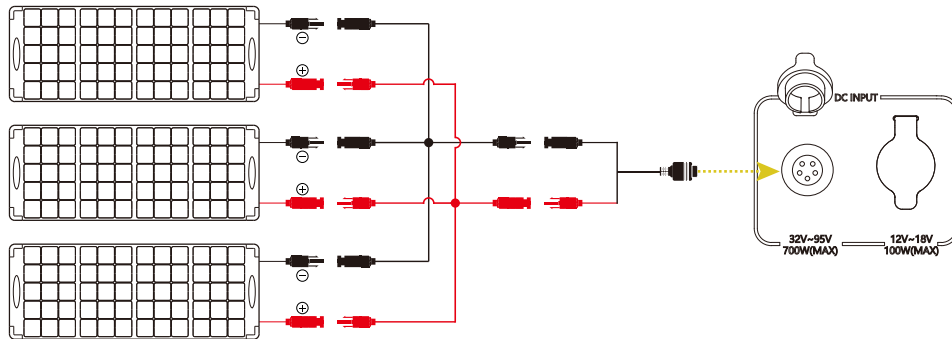

MC4 Solar Charging Cable x 1

Y Branch MC4 Charging Cable(+) x 1

Y Branch MC4 Charging Cable(-) x 1

(NOTE : The Y branch cables are sold separately)

The V_{oc} of each solar panel should not exceed 95V, and the V_{mp} should be greater than 32V. Parallel wiring effectively combines the amperage, not the voltage.

CAUTION - THREE SOLAR PANELS IN SERIES CAN DAMAGE THE UNIT.

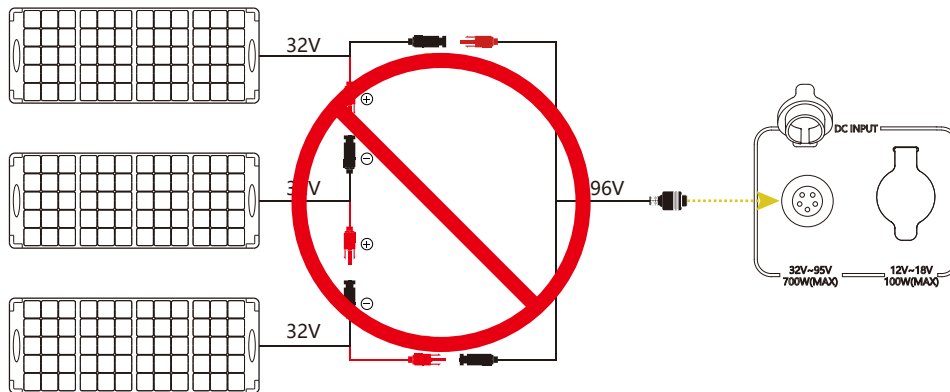

*PV (GX16MF-5) Port will only accept 32V-95V Open Circuit voltage, exceeding 95V will damage the MPPT.

FAQS

Q1 : What kind of battery is used in PEAK 2.2 unit and what is its life expectancy?

A : PEAK 2.2 utilises high quality UL certified automotive LiFePO4 battery cells, it can retain 80% of its original capacity at 3500 complete charge cycles.

Q2 : What devices can PEAK 2.2 power?

A : Please note that the AC output port can only charge or power devices that operate at less than 2200W. The DC output port is limited to 12V-30A charging input or load.

Q3 : Can the PEAK 2.2 be used as UPS?

A : PEAK 2.2 supports UPS function with an automatic switchover time of 8-20ms.

Q4 : How do I calculate the PEAK 2.2 run time?

A : Run Time = Total Capacity (1536Wh) * 0.85 (Depth of Discharge)/Load (Watts)

Q5 : Does the PEAK 2.2 have a built-in MPPT charge controller?

A : Yes, there are two independent built-in MPPT charge controllers; "5521" port supports 12-18V (Max 100W) PV input, and "GX16MF" port supports 32-95V (Max 700W) input.

Q6 : Can the PEAK 2.2 be charged while discharging?

A : Yes, It can be charged and discharged at the same time. In the non-UPS state, if uninterrupted use is required, the average charging power must be greater than the average load power, otherwise the battery will eventually run out and shut down.

Q7 : How to store the PEAK 2.2?

A : Please turn off the unit and then store it in a dry, ventilated place at normal room temperature. Do not place this unit near water sources or a wet/moist environment. For long-term storage, we recommend discharging the battery to 30% every three months and recharging it to 60% to sustain the battery life.

Q8 : Is there any other safety advice?

A : This product is IP rated 20 and is therefore NOT waterproof.

Ensure adequate space is made for the vent fans to dissipate internal heat when in use.

Do not use the product in environments where volatile gas may be present.

DISCLAIMER

Please read the user manual thoroughly before using this product, and keep this manual in a safe place for future reference. Failure to follow the instructions for proper set up, use, and care for the device can increase the risk of serious personal injury, death, or property damage. Once you use this device, you are deemed to have understood, recognised and accepted all terms and contents of this document. The user shall be responsible for their own actions and all consequences arising from failure to use the device in accordance with the “User Manual” , or as authorised in the current product literature.

In compliance with laws and regulations, Sherpa Tek Ltd reserves all rights for final explanation, and to change these terms and conditions at any time without prior notice. In the event that any revisions are made, the revised terms and conditions shall be posted on our website immediately, please visit our website to inform yourself of any changes.

SAFETY ADVICE

1. Do not place the device near heat source, such as a fire or a heating furnace.
2. Do not immerse in any liquid, or expose the unit to rain or wet conditions.
3. Do not use the battery in a strong static electricity or electromagnetic environment.
4. Do not disassemble or puncture the product with sharp objects in any way.
5. Short circuits can be caused by: vermin or pests chewing through wires; water or other fluids coming into contact with electrical wiring.
6. It's prohibited to be used as car jump starter, only can be used to charge the car battery.
7. Do not use accessories or parts other than those provided by original factory.

8. When using this product, please follow the ambient temperature guidelines in the user manual. If the battery temperature becomes excessively high, it can degrade the capacity as would exposure to an excessively low temperature environment.
9. Do not stack heavy objects on this product.
10. Do not block the air vents during use, or leave the device in a non-ventilated or dusty space.
11. Avoid impacts and violent vibration to the unit. Please turn off the device immediately and stop using it in the event of major exterior impact. Please fasten the unit firmly during transportation to avoid vibration and impact.
12. In the event of immersing the device into the water accidentally, please place the unit in a safe open area and keep away from the unit until it is completely dry. The unit should not be reused and should be disposed of properly according to the local regulation. If the device catches fire, use the fire extinguishing equipment in the following recommended order: water or mist, sand, fire blanket, dry chemical, carbon dioxide fire extinguisher.
13. To clean the surface of the device, wipe with a dry cloth.
14. Please store this device in a place out of reach of children and pets.

DISPOSAL

1. When conditions permit, please be sure to completely discharge the battery of this product, and then put the product in the designated battery recycling box. This product contains batteries which contain dangerous chemicals and are strictly prohibited from being disposed of in general waste. For details, please follow local laws and regulations on battery recycling and disposal.
2. If the battery cannot be completely discharged due to the failure of the product itself, please do not dispose of the battery directly in the battery recycling box, and contact a professional battery recycling company for further advice.
3. The battery can enter a deep discharge state if left to drain over a long period and will no longer be able to accept charge, please dispose of it according to current waste regulations.

WARRANTY EXCLUSIONS

1. Misused, abused, damaged by accident or damaged due to force majeure (e.g. lightning strikes, hurricane, floods, etc.)
2. Unauthorised modification, repair, dis-assembly or operation not in accordance with the official instructions or manuals.
3. Any defects or damages caused by reliability or compatibility issues when using unauthorised third-party parts.
4. Purchase from unauthorised resellers.
5. Use for special applications other than normal consumer use.
6. Lost, stolen or fully refunded product.
7. Any defect or damage caused by exposure to excessive heat, cold, liquids or other external causes.
8. Invalid proof of purchase.
9. Warranty period expired.
10. The battery model on the warranty certificate does not match the actual item.
11. Unauthorised alteration on the warranty certificate.
12. Product wear and tear from general use.

CUSTOMER SUPPORT : www.sherpapower.co.uk

www.sherpapower.co.uk

Sherpa Tek Ltd.

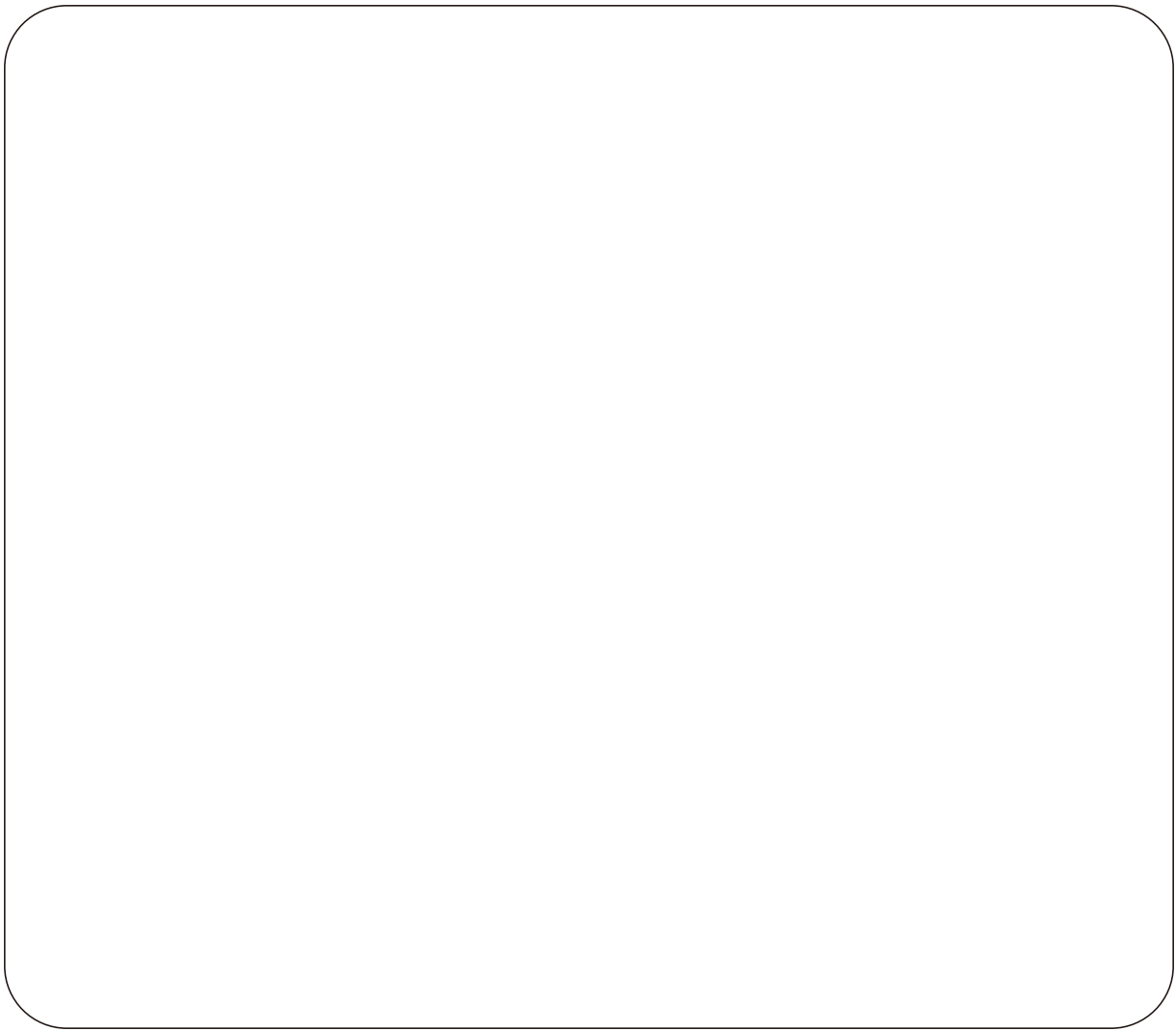



Own Your Energy